



PRODUCTS CATALOG

MOTORCYCLE & BIKE SECURITY

2025

ABOUT US



- 1998** **STARTING STRONG**
Back in 1998, Kovix began its journey with a clear goal - to develop high-quality locks to resist attacks and deter theft.
- 2000** **THE ROAD TO INNOVATION**
Innovation is at the core of Kovix, shaping our brand and reputation. In 2000, we brought together talented engineers to enhance our security tech and boost brand recognition through our R&D division.
- 2004** **EXPANDING GLOBALLY**
Recognizing the growing potential in the global market, we have firmly believed in our ability to deliver outstanding value to riders worldwide. In 2004, our offerings received highly positive feedback in the local market, inspiring us to expand our products to reach riders beyond our home.
- 2021** **INTRODUCING THE FIRST ALARM TRAILER COUPLER LOCK**
Despite significant advancements in security locks, the theft of outdoor gear continues to be a global issue. To tackle this challenge, we introduced the ground-breaking Kovix Outdoor series in 2021. We take pride in being the first manufacturer to integrate a 120dB alarm with traditional Trailer Coupler Locks and Marine Locks, boosting their security to another level.
- 2022** **EXPANDING TO THE BIKE LOCK MARKET**
Originally known for our expertise in motorcycle locks, we expanded into the bicycle lock industry in 2022 with the launch of the Steel Thunder Series. This new product line offers cycling enthusiasts a variety of security options, featuring our signature 120dB alarm, durable steel construction, and accreditation from independent bodies, including Dutch ART, French SRA, and UK Sold Secure.
- 2024** **SETTING THE BAR HIGHER**
Kovix products are known for being tough, durable, and safe. To keep our promise, we have set up a professional test lab to ensure the products are meeting the international security standards. From tensile test to hardness checks, our tests are designed specifically for bike and motorcycle locks, guaranteeing our products are fulfilling the international security standards, as well as individual customer requirements.

THE JOURNEY AHEAD...

As we move forward, we stick to our original goal of offering a variety of security products for two-wheel enthusiasts. Our journey is filled with new ideas, quality, and a firm commitment to protecting what's important.

WHO GONNA TELL THE QUALITY ?



A TRUE PROMISE

Throughout the years, our goals have remained unwavering. Kovix is dedicated to delivering high-quality security accessories for outdoor rides. Our steadfast commitment to excellence ensures that our customers can trust in the reliability and effectiveness of our products.

2025 CATALOG

SECURITY CERTIFICATIONS	01
SECURITY RATING	02
STEEL THUNDER SERIES	03
DISC LOCK	05
SMART LOCK	25
U LOCK	27
CHAIN & CABLE LOCK	35
FOLDING LOCK	47
PAD LOCK	51
GRIP LOCK	55
GROUND ANCHOR	59
HELMET LOCK	61
PHONE MOUNT	63
ACCESSORIES	65

SECURITY CERTIFICATIONS



ART FOUNDATION NETHERLANDS

Promotes security against theft by formulating requirements for mechanical safeguards for two-wheelers. Durability, Weather resistance, Machine, and Manual attack tests are usually performed to testify to the preventive value of a lock. The more stars a lock has, the higher its preventive value and the better it protects against theft. A lock with five stars has the most preventive value.



SOLD SECURE UK

Sold Secure is the UK's premier testing and certification body for all security products, dedicated to reducing the risk of crime by assessing security products through power tools, machine-based testing, and physical attack testing. Products that have passed a satisfactory evaluation will carry the coveted Sold Secure Approved quality mark.



CLASSE SRA FRANCE

SRA (SECURITY AND REPAIR OF AUTOMOBILES) is a professional organization established in France in 1977. Part of the SRA's primary mission is to participate in the prevention of vehicle theft. Classe SRA requires a highly detailed drawing of the lock before testing to determine the lock's weakest point. Then, sawing, lever/wedge attack, and drilling tests will be performed to evaluate the security product.

SECURITY RATING



1-3 EVERYDAY SECURITY

Locks rated 1-3 are suitable for low-risk areas and rural areas. Lightweight and portable, they offer basic safety, perfect for daily use.



4-6 SOLID SECURITY

Locks rated 4-6 are ideal for areas with low to medium theft risk and overnight rural parking. They are solid and recommended for urban riders.



7-9 EXTRA SECURITY

Locks rated 7-9 are considered high-security, effective against physical attacks. They are robust and best suited for medium to high theft-risk areas, such as college campuses and urban settings.



10-10+ ULTIMATE SECURITY

Security level 10 locks offer the highest level of security, enhanced resistance to physical attacks, and accreditation by independent testing bodies. Virtually indestructible, they are perfect for the highest theft-risk areas and urban overnight stays.



ALARM BOOST FEATURE

Enhanced with a 120-decibel alarm audible up to 1,500 feet, the motion sensor triggers an immediate alarm upon tampering. Additionally, weather-resistant, the lock can withstand rain, sand, and dust, ensuring reliability in various environmental conditions.

STEEL THUNDER



ROBUST ALARM ASSURED

The STEEL THUNDER bike locks are made from sturdy stainless steel and hardened steel, ensuring maximum security and rust resistance for cycling enthusiasts. Each lock in the range features a built-in 120-decibel alarm that emits a piercing sound to deter thieves when tampered with. Additionally, these locks come with IP67 waterproof certification, enabling them to withstand harsh weather conditions and ensuring your bike remains safe in any environment.

This new range has been certified by independent organizations, including Dutch ART, French SRA, and UK Sold Secure. These certification bodies are recognized and trusted for their thorough testing of lock quality in the industry, highlighting the excellence of the STEEL THUNDER range.

Experience a new level of safety with the Kovix STEEL THUNDER Series, designed to provide riders with the highest level of protection.

DISC LOCK

P. 16



KHS 16N



KHS 16

U LOCK

P. 29



KTQ14-230



KTQ14-300



KTQ14-230 SS

CHAIN LOCK

P. 37



KCC08



KCC10



KCC12



KHS 16N + KC12

PADLOCK

P. 53



KPQ8.5



KPQ10



KPQ12

DISC LOCK

Robust Siren Disc Brake Lock against motorcycle thefts.



OUR MECHANISM

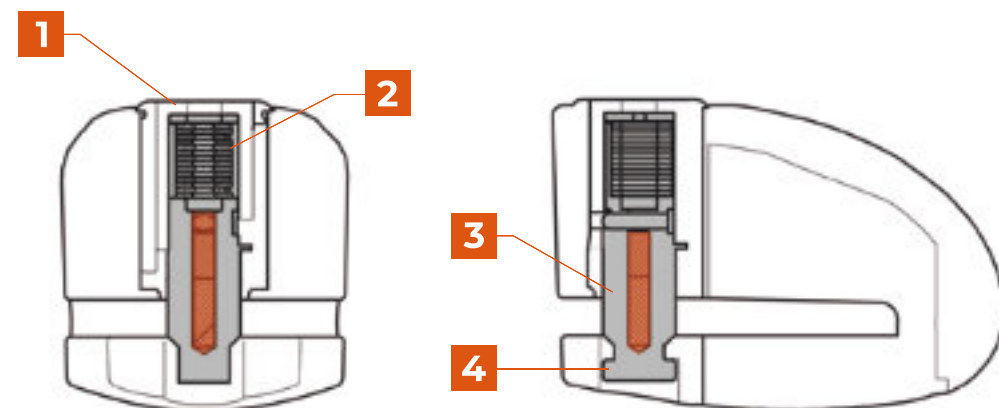

1. DISC TUMBLER LOCK MECHANISM

Composed of multiple rotating discs, only a specially cut key can turn the discs and allow the lock to open. Discs and keys are uniquely cut into over 15,000 combinations. The mutual opening rate is extremely low.

2. STAINLESS STEEL DISC PLATES

Strong material with resistance to lock picking, drilling and bumping.

3. CARBIDE REINFORCED STEEL LOCKING PIN

The locking pin has passed various tests performed by security agencies and is proven to resist bolt cutters and saw blades.

4. DOUBLE LOCK MECHANISM

Twin-spar lock chassis for double strength, cut and tensile resistance.



OVERLORD



KNX15 ALARM DISC LOCK

Built-in 120dB anti-theft security alarm
Alarm function selection ARM/ DISARM

Ø14mm steel locking pin
Double locking mechanism
Pick and drill proof disc-style cylinder

Stainless steel construction
100% rust-proof lock body
Weather-proof electronic module



14
MM



DIMENSIONS *ALL Dimensions in mm

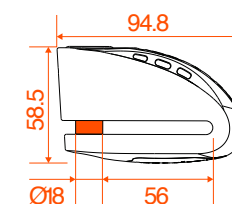

OVERLORD

OVERLORD X

KNX10 ALARM DISC LOCK

Built-in 120dB anti-theft security alarm
Alarm function selection ARM/ DISARM

Ø10mm steel locking pin
Double locking mechanism
Pick and drill proof disc-style cylinder

Alloy steel construction
100% rust-proof lock body
Weather-proof electronic module



10
MM



DIMENSIONS *All Dimensions in mm

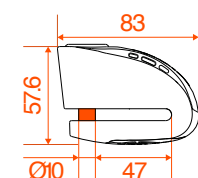

OVERLORD X

KNX6 ALARM DISC LOCK

Built-in 120dB anti-theft security alarm
Alarm function selection ARM/ DISARM

Ø6mm steel locking pin
Easy pushdown-and-click mechanism
Pick and drill proof disc-style cylinder

Alloy steel construction
100% rust-proof lock body
Weather-proof electronic module



6
MM



DIMENSIONS *All Dimensions in mm

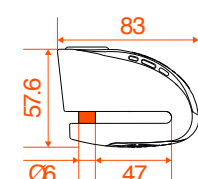

OVERLORD

KNS6 ALARM DISC LOCK

Built-in 120dB anti-theft security alarm
Alarm function selection ARM/ DISARM

Ø6mm steel locking pin
Easy pushdown-and-click mechanism
Pick and drill proof disc-style cylinder

Mini size - ideal for scooters, e-bikes
Alloy steel construction
100% rust-proof lock body
Weather-proof electronic module



6
MM



DIMENSIONS *All Dimensions in mm

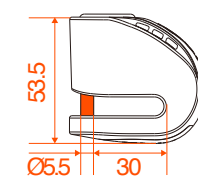

NEW PRODUCT



KDS-006 ALARM DISC LOCK

Built-in 120dB anti-theft security alarm
Alarm function selection ARM/ DISARM

Ø6mm steel locking pin
Easy pushdown-and-click mechanism
Pick and drill proof disc-style cylinder

Alloy steel construction
100% rust-proof lock body
Weather-proof electronic module



6 MM



DIMENSIONS *ALL Dimensions in mm

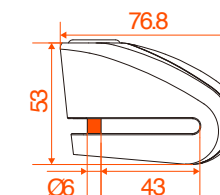

NEW PRODUCT



KDS-001
ALARM DISC LOCK

Built-in 120dB anti-theft security alarm
Alarm function selection ARM/ DISARM



Ø5.5mm steel locking pin
Easy pushdown-and-click mechanism
Pick and drill proof disc-style cylinder



Alloy steel construction
100% rust-proof lock body
Weather-proof electronic module



DIMENSIONS *All Dimensions in mm

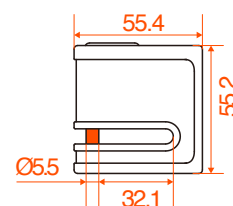

CABLE SET

included with 180cm*6mm high-strength cable



KD6
ALARM DISC LOCK

Built-in 120dB anti-theft security alarm
Alarm function selection ARM/ DISARM



Ø6mm steel locking pin
Easy pushdown-and-click mechanism
Pick and drill proof disc-style cylinder



Alloy steel construction
100% rust-proof lock body
Weather-proof electronic module



DIMENSIONS *All Dimensions in mm

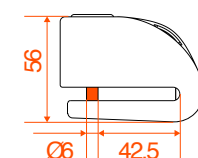

KT6
ALARM DISC LOCK

Built-in 120dB anti-theft security alarm
Alarm function selection ARM/ DISARM



Ø6mm steel locking pin
Easy pushdown-and-click mechanism
Pick and drill proof disc-style cylinder



Alloy steel construction
100% rust-proof lock body
Weather-proof electronic module



DIMENSIONS *All Dimensions in mm

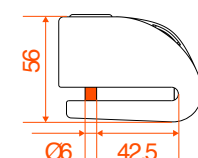

KT6/CB

ALARM DISC LOCK

Built-in 120dB anti-theft security alarm
Alarm function selection ARM/ DISARM

Ø6mm steel locking pin
Easy pushdown-and-click mechanism
Pick and drill proof disc-style cylinder

Mini size - ideal for scooters
Plastic-coated manganese steel construction
100% rust-proof lock body
Weather-proof electronic module

DIMENSIONS *ALL Dimensions in mm

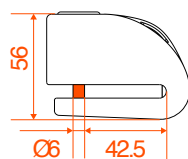

6
MM

MANGANESE
STEEL



KS6

ALARM DISC LOCK

Built-in 120dB anti-theft security alarm
Alarm function selection ARM/ DISARM

Ø5.5mm steel locking pin
Easy pushdown-and-click mechanism
Pick and drill proof disc-style cylinder

Mini size - ideal for scooters, e-bikes
Alloy steel construction
100% rust-proof lock body
Weather-proof electronic module

DIMENSIONS *ALL Dimensions in mm

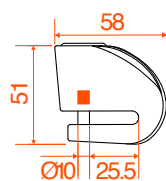

5.5
MM



KHS 16N

DISC LOCK

Ø16mm hardened steel shackle
Ultra cutting and sawing resistant
High pick and drill resistant disc-style cylinder

Hardened steel construction
Use as disc brake lock or pair with chain

DIMENSIONS *ALL Dimensions in mm

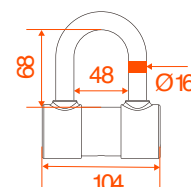

16
MM

HARDENED
STEEL



KHS 16

DISC LOCK

Ø16mm hardened steel shackle
Ultra cutting and sawing resistant
High pick and drill resistant disc-style cylinder

Stainless steel construction
100% rust-proof lock body
Use as disc brake lock or pair with chain

DIMENSIONS *ALL Dimensions in mm

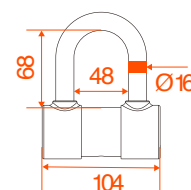

16
MM

STAINLESS
STEEL



NEW PRODUCT



KDS-002
DISC LOCK

EnhancedShield-shaped structure against leverage attacks
Ø6mm steel locking pin
Easy pushdown-and-click mechanism
Pick and drill proof disc-style cylinder

6
MM

Stainless steel construction
100%rust-proof lock body



DIMENSIONS *ALL Dimensions in mm

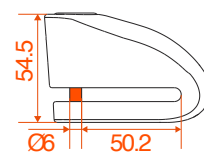

NEW PRODUCT



KDS-003
DISC LOCK

EnhancedShield-shaped structure against leverage attacks
Ø10mm steel locking pin
Double locking mechanism
Pick and drill proof disc-style cylinder

10
MM

Stainless steel construction
100%rust-proof lock body



DIMENSIONS *ALL Dimensions in mm

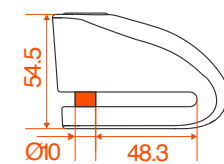

NEW PRODUCT



OVERLORD

KNN1
DISC LOCK

Ø5.5mm steel locking pin
Easypushdown-and click mechanism
Pick and drill proof disc-style cylinder

Mini size - ideal for scooters,e-bikes
Alloy steel construction
100%rust-proof lock body

5.5
MM



DIMENSIONS *All Dimensions in mm

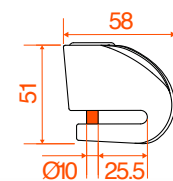

NEW PRODUCT



OVERLORD

KNN1/CB
DISC LOCK

Ø5.5mm steel locking pin
Easypushdown-and-click mechanism
Pick and drill proof disc-style cylinder

Mini size - ideal for scooters,e-bikes
Plastic-coated manganese steel construction
100%rust-proof lock body

5.5
MM



DIMENSIONS *All Dimensions in mm

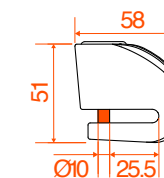

CABLE SET

included with 180cm*6mmhigh-strength cable



KNN6/CB

DISC LOCK

Ø6mm steel locking pin
Easypushdown-and-click mechanism
Pick and drill proof disc-style cylinder

Plastic-coated manganese steel construction
100%rust-proof lock body



DIMENSIONS *ALL Dimensions in mm

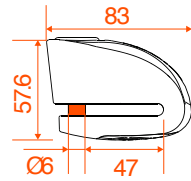

KN1

DISC LOCK

Ø5.5mm steel locking pin
Easypushdown-and-click mechanism
Pick and drill proof disc-style cylinder

Mini size - ideal for scooters,e-bikes
Alloy steel construction
100%rust-proof lock body



DIMENSIONS *ALL Dimensions in mm

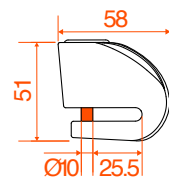

KVC1

DISC LOCK

Ø6mm steel locking pin
Easypushdown-and-click mechanism
Pick and drill proof disc-style cylinder

Steel construction
100%rust-proof lock body



DIMENSIONS *ALL Dimensions in mm

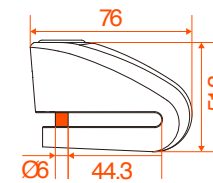

KVC2

DISC LOCK

Ø14mm steel locking pin
Double locking mechanism
Pick and drill proof disc-style cylinder

Steel construction
100%rust-proof lock body



DIMENSIONS *ALL Dimensions in mm

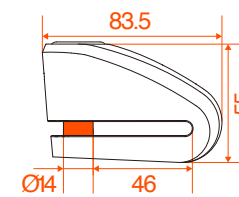



KVZ1 DISC LOCK

Ø6mm steel locking pin
Easy pushdown-and click mechanism
Pick and drill proof disc-style cylinder

Alloy steel construction
100%rust-proof lock body

**6
MM**



DIMENSIONS *ALL Dimensions in mm

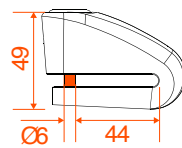

KVS1 DISC LOCK

Ø6mm steel locking pin
Easy pushdown-and click mechanism
Pick and drill proof disc-style cylinder

Stainless steel construction
100%rust-proof lock body

**6
MM**



DIMENSIONS *ALL Dimensions in mm

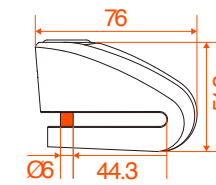

KVZ2 DISC LOCK

Ø14mm steel locking pin
Double locking mechanism
Pick and drill proof disc-style cylinder

Alloy steel construction
100%rust-proof lock body

**14
MM**



DIMENSIONS *ALL Dimensions in mm

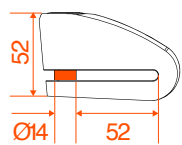

KVS2 DISC LOCK

Ø14mm steel locking pin
Double locking mechanism
Pick and drill proof disc-style cylinder

Stainless steel construction
100%rust-proof lock body

**14
MM**

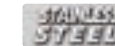

DIMENSIONS *ALL Dimensions in mm

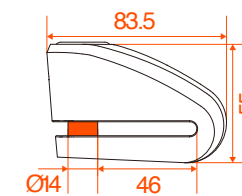

smart. LOCK

Introducing the Kovixsmart lock, a revolutionary security solution that offers both convenience and security. With its advanced features such as keyless unlocking through Bluetooth®3.0 and fingerprint recognition, this lock redefines the way you secure your beloved bike. The U shackle, made from hardened steel, guarantees exceptional durability and resistance to rust, ensuring long-lasting reliability.







Experience the future of security with the Kovixsmart lock – the perfect blend of convenience, durability, and advanced protection.



What sets the Kovixsmart lock apart is its inbuilt 120-decibel alarm system. This advanced feature activates upon detecting any movement, effectively deterring tampering and amplifying security. The lock also allows for easy access sharing, making it perfect for scenarios where multiple users need access to the same lock.



KSC-U2i SMART U LOCK

-  Fingerprint unlock
-  Built-in 120dB anti-theft security alarm
-  Location tracking
-  Authorization
-  14mm hardened steel U shackle
-  IP67 Weatherproof

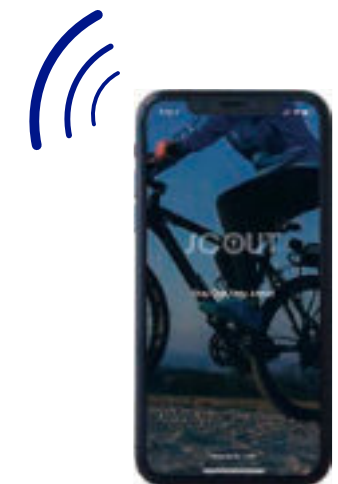

DIMENSIONS *ALL Dimensions in mm

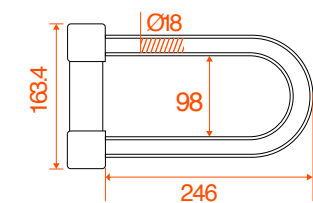



U LOCK

Sturdy hardened steel shackle U lock resists hand tools, bolt cutters and lever attacks. Built-in shock-motion activated 120decibels alarm powered by a long-life lithium battery for high-performance in all conditions.



STEEL THUNDER

KTQ14-230

ALARM U LOCK

Built-in 120dB anti-theft security alarm
Alarm function selection ARM/ DISARM



Ø14mm hardened Arch-shape U steel shackle
Soft coating to prevent damage to paintwork
High cutting and sawing resistant
Pick and drill resistant disc-style cylinder

**14
MM**

Ideal for locking on frame, back wheel, and bike rack
Hardened steel construction
100% rust-proof lock body
Weather-proof electronic module



DIMENSIONS *ALL Dimensions in mm

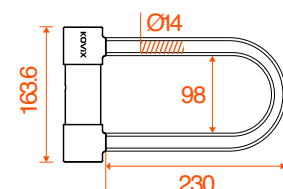

CABLE SET

included with 120cm*12mm high-strength cable

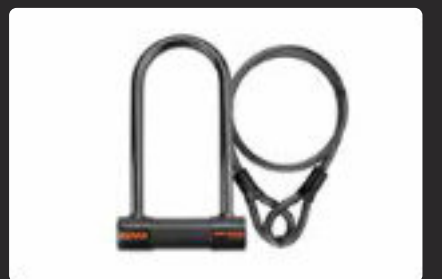

STEEL THUNDER

KTQ14-300

ALARM U LOCK

Built-in 120dB anti-theft security alarm
Alarm function selection ARM/ DISARM



Ø14mm hardened Arch-shape U steel shackle
Soft coating to prevent damage to paintwork
High cutting and sawing resistant
Pick and drill resistant disc-style cylinder

**14
MM**

Ideal for locking on frame, back wheel, and bike rack
Hardened steel construction
100% rust-proof lock body
Weather-proof electronic module



DIMENSIONS *ALL Dimensions in mm

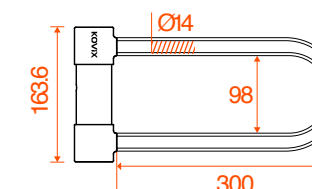

CABLE SET

included with 120cm*12mm high-strength cable





STEEL THUNDER

KTQ14-230

ALARM U LOCK

Built-in 120dB anti-theft security alarm
Alarm function selection ARM/ DISARM



Ø14mm hardened Arch-shape U steel shackle
Soft coating to prevent damage to paintwork
High cutting and sawing resistant
Pick and drill resistant disc-style cylinder

14
MM

Ideal for locking on frame, back wheel, and bike rack
Hardened steel construction
100% rust-proof lock body
Weather-proof electronic module



DIMENSIONS *ALL Dimensions in mm

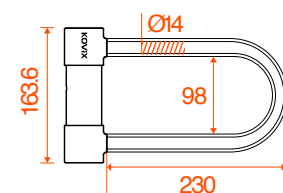

KTL14-150**ALARM U LOCK**

Built-in 120dB anti-theft security alarm
Alarm function selection ARM/ DISARM

Ø14*150mm hardened steel shackle
Cutting and sawing resistant
Pick and drill proof disc-style cylinder

Alloy steel construction
Protected vinyl coating
100% rust-proof lock body
Weather-proof electronic module

DIMENSIONS *ALL Dimensions in mm

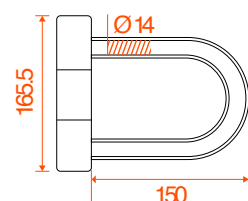

14
MM

**KTL14-300****ALARM U LOCK**

Built-in 120dB anti-theft security alarm
Alarm function selection ARM/ DISARM

Ø14*300mm hardened steel shackle
Cutting and sawing resistant
Pick and drill proof disc-style cylinder

Alloy steel construction
Protected vinyl coating
100% rust-proof lock body
Weather-proof electronic module

DIMENSIONS *ALL Dimensions in mm

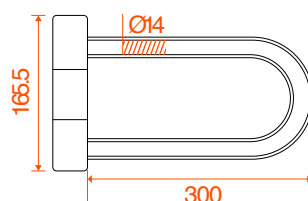

14
MM

**KTL16-210****ALARM U LOCK**

Built-in 120dB anti-theft security alarm
Alarm function selection ARM/ DISARM

Ø16*210mm hardened steel shackle
Cutting and sawing resistant
Pick and drill proof disc-style cylinder

Alloy steel construction
Protected vinyl coating
100% rust-proof lock body
Weather-proof electronic module

DIMENSIONS *ALL Dimensions in mm

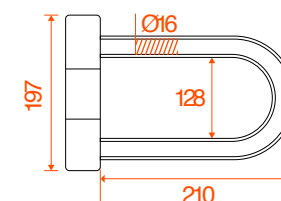

16
MM



CHAIN & CABLE LOCK

Rugged steel chains and cables are available in various thicknesses and lengths, offering many ways of locking motorcycles or bikes to fixed objects. Built-in shock-motion activated 120decibels alarm powered by a long-life CR2lithium battery for high-performance in all conditions.





STEEL THUNDER

KCQ08 ALARM CHAIN LOCK

Built-in 120dB anti-theft security alarm
Alarm function selection ARM/ DISARM

Ø8mm hardened steel chain
Durable webbing sleeve for scratch prevention
High pick and drill resistant disc-style cylinder

Carbon steel lock body
Long lifespan CR2 lithium battery
Weather-proof electronic module



STEEL THUNDER

KCQ08 AL ALARM CHAIN LOCK

Built-in 120dB anti-theft security alarm
Alarm function selection ARM/ DISARM

Ø8mm hardened steel chain
Durable webbing sleeve for scratch prevention
High pick and drill resistant disc-style cylinder

Alloy steel lock body
Long lifespan CR2 lithium battery
100% rust-proof lock body
Weather-proof electronic module



LENGTH OPTIONS



Ø8*1000mm



Ø8*1200mm

DIMENSIONS *ALL Dimensions in mm

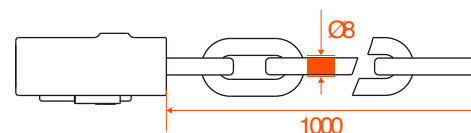

STEEL THUNDER

KCQ08 LR44 ALARM CHAIN LOCK

Built-in 120dB anti-theft security alarm
Alarm function selection ARM/ DISARM

Ø8mm hardened steel chain
Durable webbing sleeve for scratch prevention
High pick and drill resistant disc-style cylinder

Carbon steel lock body
LR44 battery
Weather-proof electronic module



STEEL THUNDER

KCQ10
ALARM CHAIN LOCK

Built-in 120dB anti-theft security alarm
Alarm function selection ARM/ DISARM
Ø10mm reinforced hardened steel square chain
Durable oxford cloth chain cover for scratch prevention
High pick and drill resistant disc-style cylinder
Hardened steel lock body
Long lifespan CR2 lithium battery
Weather-proof electronic module



DIMENSIONS *ALL Dimensions in mm

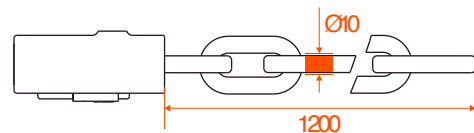

STEEL THUNDER

KCQ12
ALARM CHAIN LOCK

Built-in 120dB anti-theft security alarm
Alarm function selection ARM/ DISARM
Ø12mm reinforced hardened steel square chain
Durable oxford cloth chain cover for scratch prevention
High pick and drill resistant disc-style cylinder
Hardened steel lock body
Long lifespan CR2 lithium battery
Weather-proof electronic module



DIMENSIONS *ALL Dimensions in mm

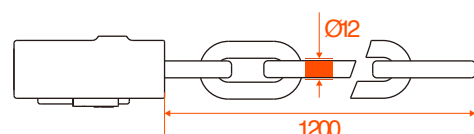

KHS 16N + KC12-120
SQUARE CHAIN LOCK

Ø16mm hardened steel shackle
Ultra cutting and sawing resistant
High pick and drill resistant disc-style cylinder
Full hardened steel construction
Ø12mm Reinforced hardened steel SQUARE chain



KHS 16N + KC12-150
SQUARE CHAIN LOCK

Ø16mm hardened steel shackle
Ultra cutting and sawing resistant
High pick and drill resistant disc-style cylinder
Full hardened steel construction
Ø12mm Reinforced hardened steel SQUARE chain



DIMENSIONS *ALL Dimensions in mm

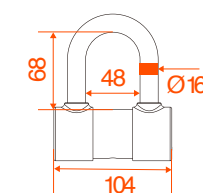

NEW PRODUCT

TRACKING TAG
COMPATIBILITY

KCH-005

ALARM CHAIN LOCK

Adjustable length and flexibility to secure scooters and bikes to various objects
Area for integrating tracking tag

Built-in 120dB anti-theft security alarm
Alarm function selection ARM/ DISARM

Ø6mm steel chain
Nylon cloth chain cover for scratch prevention
High pick and drill resistant disc-style cylinder
Alloy steel lock body

Long lifespan CR2 lithium battery
Weather-proof electronic module

16
MM

DIMENSIONS *ALL Dimensions in mm

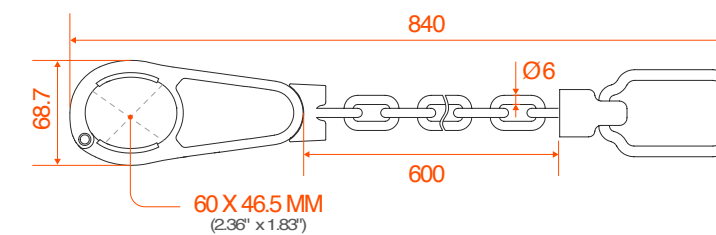

HOW TO LOCK

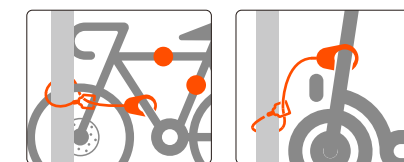



KCL08-120 ALARM CHAIN LOCK

Built-in 120dB anti-theft security alarm
Alarm function selection ARM/ DISARM

Ø8*1200mm reinforced hardened steel chain
Durable webbing sleeve for scratch prevention
Pick and drill resistant disc-style cylinder

Steel construction
100% rust-proof lock body
Weather-proof electronic module



8
MM



DIMENSIONS *ALL Dimensions in mm

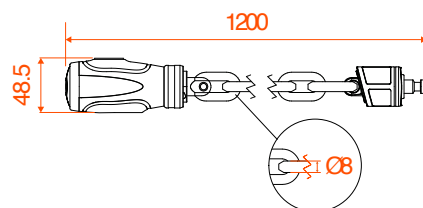

KCL10-120 ALARM CHAIN LOCK

Built-in 120dB anti-theft security alarm
Alarm function selection ARM/ DISARM

Ø10*1200mm reinforced hardened steel chain
Durable webbing sleeve for scratch prevention
Pick and drill resistant disc-style cylinder

Steel construction
100% rust-proof lock body
Weather-proof electronic module



10
MM



DIMENSIONS *ALL Dimensions in mm

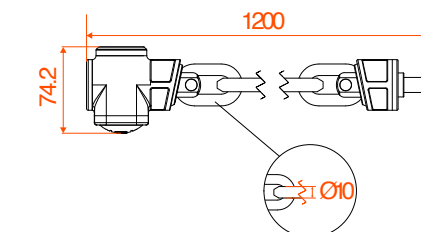

KCL10-150 ALARM CHAIN LOCK

Built-in 120dB anti-theft security alarm
Alarm function selection ARM/ DISARM

Ø10*1500mm reinforced hardened steel chain
Durable webbing sleeve for scratch prevention
Pick and drill resistant disc-style cylinder

Steel construction
100% rust-proof lock body
Weather-proof electronic module



10
MM



DIMENSIONS *ALL Dimensions in mm

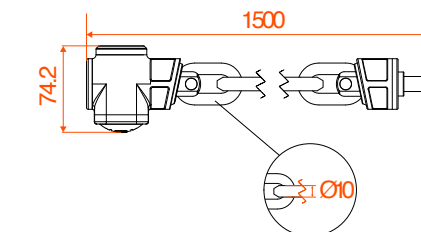



KCL12-120

ALARM CHAIN LOCK

Built-in 120dB anti-theft security alarm
Alarm function selection ARM/ DISARM

Ø12*1200mm reinforced hardened steel chain
Durable webbing sleeve for scratch prevention
Pick and drill resistant disc-style cylinder

Steel construction
100% rust-proof lock body
Weather-proof electronic module



12
MM



DIMENSIONS *ALL Dimensions in mm

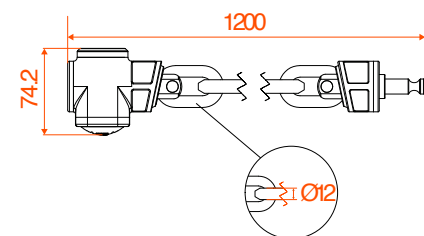

KCL12-150

ALARM CHAIN LOCK

Built-in 120dB anti-theft security alarm
Alarm function selection ARM/ DISARM

Ø12*1500mm reinforced hardened steel chain
Durable webbing sleeve for scratch prevention
Pick and drill resistant disc-style cylinder

Steel construction
100% rust-proof lock body
Weather-proof electronic module



12
MM



DIMENSIONS *ALL Dimensions in mm

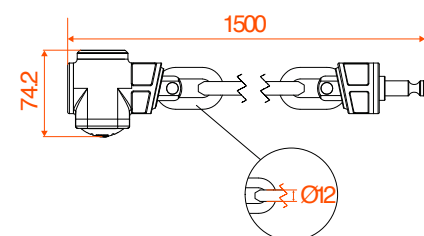

KWL24-110

ALARM CABLE LOCK

Built-in 120dB anti-theft security alarm
Alarm function selection ARM/ DISARM

Ø24*1100mm braided steel cable with PVC external glue
Soft coating to prevent damage to paintwork
Pick and drill proof disc-style cylinder

Alloy steel construction
100% rust-proof lock body
Weather-proof electronic module



24
MM



DIMENSIONS *ALL Dimensions in mm

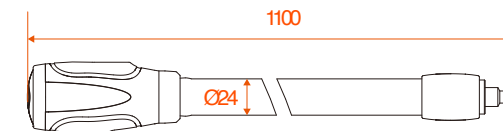

KWL24-170

ALARM CABLE LOCK

Built-in 120dB anti-theft security alarm
Alarm function selection ARM/ DISARM

Ø24*1700mm braided steel cable with PVC external glue
Soft coating to prevent damage to paintwork
Pick and drill proof disc-style cylinder

Alloy steel construction
100% rust-proof lock body
Weather-proof electronic module



24
MM



DIMENSIONS *ALL Dimensions in mm

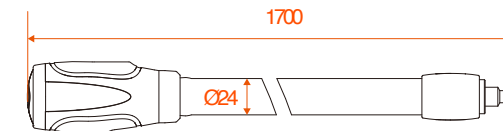

FOLDING LOCK



NEW PRODUCT



KFS-001
ALARM FOLDING LOCK

- Built-in 120dB anti-theft security alarm
- Alarm function selection ARM/ DISARM
- 8mm thick folding plates
- 110mm internal locking width
- High pick and drill resistant disc-style cylinder
- Stainless steel construction
- 100% rust-proof lock body
- Weather-proof electronic module



8
MM

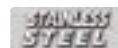

DIMENSIONS *ALL Dimensions in mm

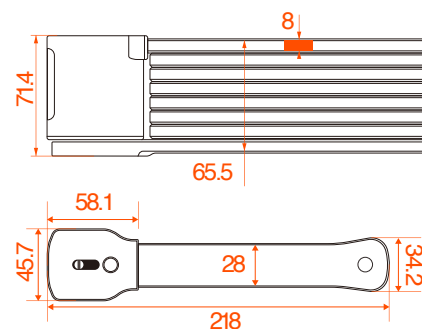

STEEL THUNDER

KFQ85
ALARM FOLDING LOCK

- Built-in 120dB anti-theft security alarm
- Alarm function selection ARM/ DISARM
- 3mm thick hardened steel plates
- 800mm internal locking width
- High pick and drill resistant disc-style cylinder
- Stainless steel construction
- 100% rust-proof lock body
- Weather-proof electronic module



14
MM



DIMENSIONS *ALL Dimensions in mm

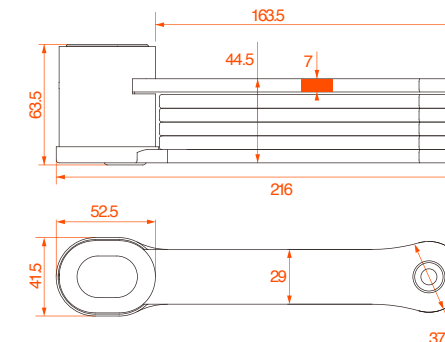

PAD LOCK

STEEL THUNDER



STEEL THUNDER

KPQ8.5
ALARM PADLOCK

Built-in 120dB anti-theft security alarm
360 degree motion and shock alarm sensor
Alarm function selection ARM/ DISARM

Ø8.5mm stainless steel shackle
Ultra cutting and sawing resistant
High pick and drill proof disc-style cylinder

Ideal for locking gate, door or pair with chain
Stainless steel construction
100%rust-proof lock body
Weather-proof electronic module

DIMENSIONS *ALL Dimensions in mm

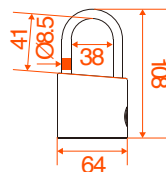

8.5
MM



CHAIN SET

KC10 Ø10mm reinforced steel chain
KC12 Ø12mm reinforced steel chain



STEEL THUNDER

KPQ10
ALARM PADLOCK

Built-in 120dB anti-theft security alarm
360 degree motion and shock alarm sensor
Alarm function selection ARM/ DISARM

Ø10mm stainless steel shackle
Ultra cutting and sawing resistant
High pick and drill proof disc-style cylinder

Ideal for locking gate, door or pair with chain
Stainless steel construction
100%rust-proof lock body
Weather-proof electronic module

DIMENSIONS *ALL Dimensions in mm

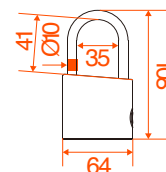

10
MM



CHAIN SET

KC10 Ø10mm reinforced steel chain
KC12 Ø12mm reinforced steel chain



STEEL THUNDER

KPQ12
ALARM PADLOCK

Built-in 120dB anti-theft security alarm
360 degree motion and shock alarm sensor
Alarm function selection ARM/ DISARM

Ø12mm stainless steel shackle
Ultra cutting and sawing resistant
High pick and drill proof disc-style cylinder

Ideal for locking gate, door or pair with chain
Stainless steel construction
100%rust-proof lock body
Weather-proof electronic module

DIMENSIONS *ALL Dimensions in mm

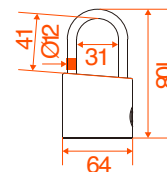

12
MM



CHAIN SET

KC10 Ø10mm reinforced steel chain
KC12 Ø12mm reinforced steel chain



KBL12
ALARM PADLOCK

Built-in 120dB anti-theft security alarm
Alarm function selection ARM/ DISARM

Ø12mm stainless steel shackle
Cutting and sawing resistant
High pick and drill proof disc-style cylinder

Ideal for locking gate, door or pair with chain
Stainless steel construction
100%rust-proof lock body
Weather-proof electronic module

DIMENSIONS *ALL Dimensions in mm

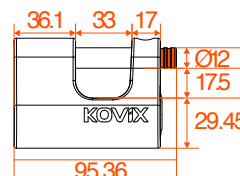

12
MM



CHAIN SET

KC10 Ø10mm reinforced steel chain
KC12 Ø12mm reinforced steel chain





GRIP LOCK

Compact, lightweight, and sturdy grip lock. Convenient to carry along on every ride. The 10mm Carbide reinforced hardened steel locking pin and built-in 120dB anti-theft security alarm offer dual tactile and audible security.

NEW PRODUCT



KGH

ALARM GRIP LOCK

Built-in 120dB anti-theft security alarm
Alarm function selection ARM/ DISARM

Ø10mm alloy steel locking pin
Easy pushdown-and-click locking mechanism
Pick and drill proof disc-style cylinder

Nylon construction
100% rust-proof lock body
Weather-proof electronic module

16
MM

DIMENSIONS *All Dimensions in mm

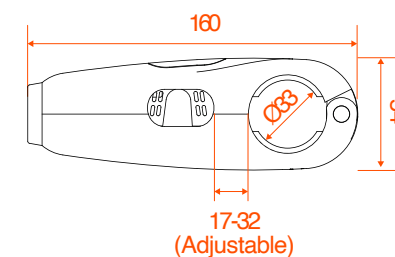

KDS/C-009

ALARM GRIP LOCK

Compact and portable for on-the-go security
Built-in 120dB anti-theft security alarm
Alarm function selection ARM/ DISARM

Ø10mm alloy steel locking pin
Easy pushdown-and-click locking mechanism
Pick and drill proof disc-style cylinder

100% rust-proof lock body
Weather-proof electronic module

10
MM

DIMENSIONS *ALL Dimensions in mm

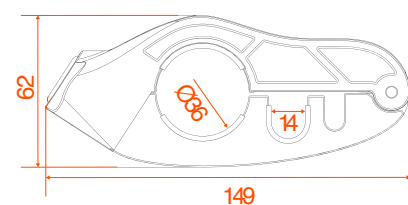

THIS PRODUCT ALSO FUNCTIONS AS A LOCK
FOR YOUR MOTORCYCLE HELMET.



GROUND ANCHOR

Solid ground anchor secure to the floor and acts as a point of reference for a chain. Full stainless steel construction resists all forms of attack.

KGA GROUND ANCHOR

112mm stainless steel case resists all forms of attack
Double-locking mechanism
Pick and drill proof disc-style cylinder

Stainless steel construction
100% rust-proof lock body

DIMENSIONS *All Dimensions in mm

**112
MM**

**STAINLESS
STEEL**



HELMET LOCK



Safeguard your valuable helmet, preventing theft and protecting it from damage.

KZTL COMBINATION LOCK

- Password unlock
- Adjustable tightness
- Alloy steel lock body
- Corrosion resistance



KHEL200 HELMET LOCK

- Password unlock
- 2m Extended Cable
- Alloy lock body
- Corrosion resistance



KHEL100 HELMET LOCK

- Password unlock
- 1.5m Extended Cable



- Alloy lock body
- Corrosion resistance



PHONE MOUNT



KPM001 MIRROR MOUNT VERSION

- 360° Rotatable
- Prevents squeezing and bumping of the camera
- 4 sets of vibration dampers to dampen vibrations
- A high-speed safety knob lock to ensure your phone never falls off
- One-Push automatic lock mechanism

KPM002 HANDLEBAR MOUNT VERSION

- 360° Rotatable
- Prevents squeezing and bumping of the camera
- 4 sets of vibration dampers to dampen vibrations
- A high-speed safety knob lock to ensure your phone never falls off
- One-Push automatic lock mechanism

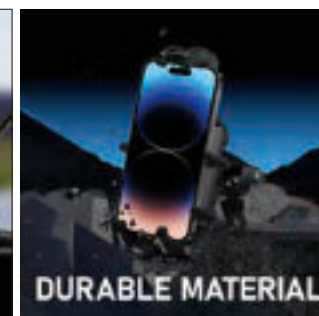

BRANDED MERCHANDISE



KBR-1
BRANDED MERCHANDISE

L: 220mm
W: 220mm
H: 220mm
Weight: 1005g



K040
BRANDED MERCHANDISE

L: 1000mm
W: 450mm
H: 2000mm
Weight: 33kg

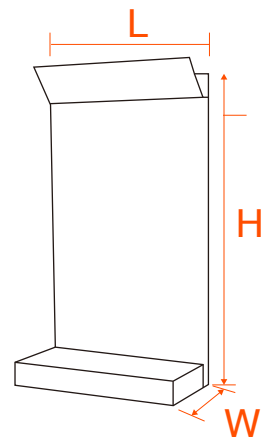

LOCK WITH **ALARM**
PROTECT WITH **CONFIDENCE**

